

USER MANUAL
LOAD MANAGER (EIPL56ER)



Version 1.0

Release Date: 24/09/2020

1. Installation

1.1 Dimension

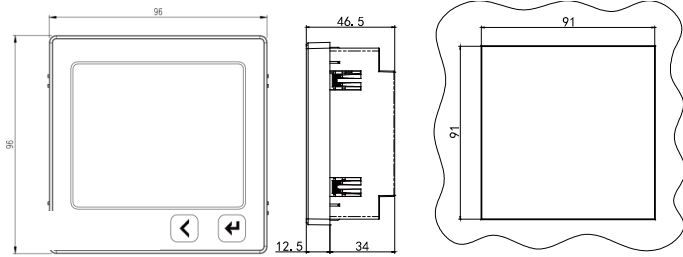

1.2 Installation

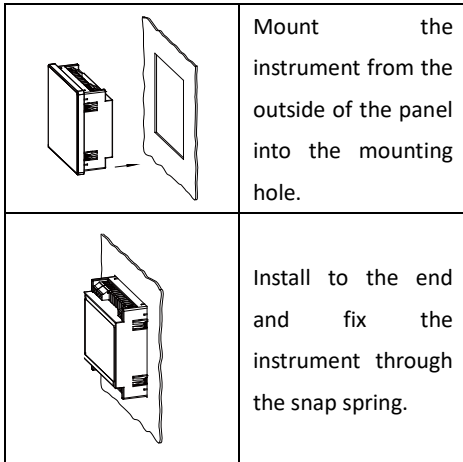

1.3 Wiring

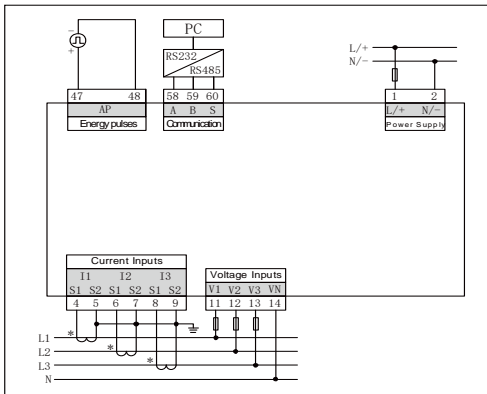

2. Operation

2.1 Panel description

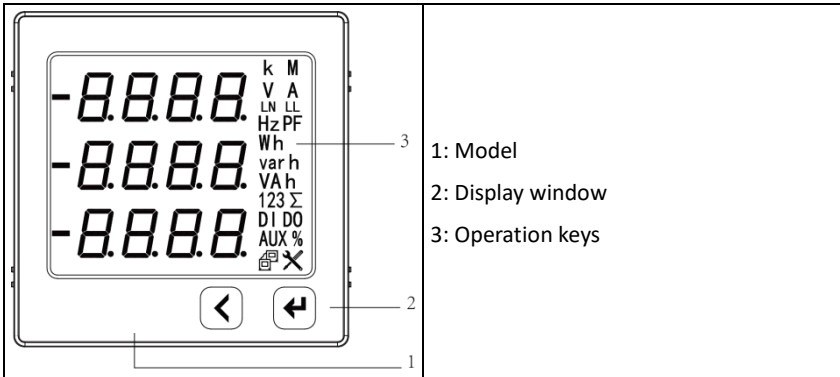

- 1: Model
- 2: Display window
- 3: Operation keys

2.2 Display

The meter can display the measurement data cyclically through the “←” or “→” key. The overview of the display interface is as follows:

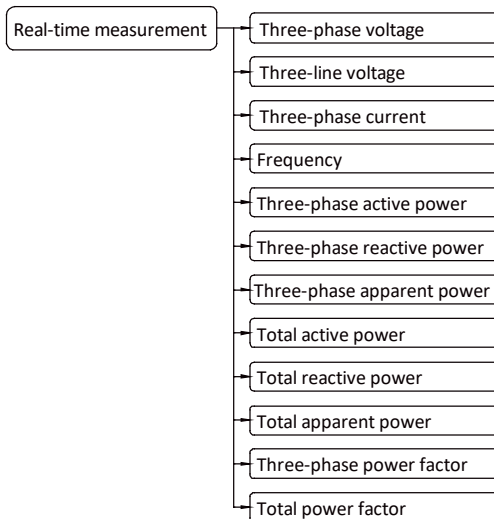

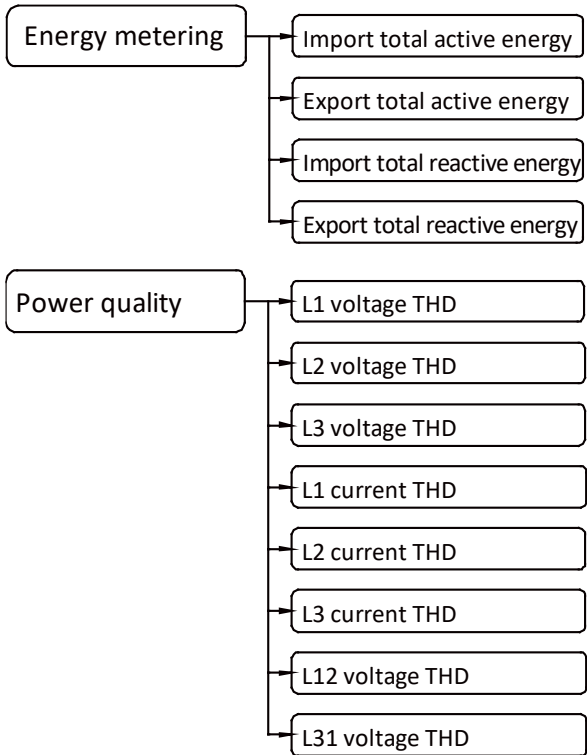



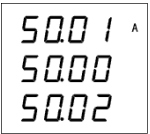





Table 2-1 Electrical variables display pages

Display interface	Instruction
	<p>Three-phase voltage</p> <p>V1=10.01kV</p> <p>V2=10.00kV</p> <p>V3=10.02kV</p>
	<p>Three-line voltage</p> <p>U12=17.31kV</p> <p>U23=17.32V</p> <p>U31=17.33V</p>
	<p>Frequency</p> <p>F=50Hz</p>
	<p>Three-phase current</p> <p>I1=5.001A</p> <p>I2=5.000A</p> <p>I3=5.002A</p>
	<p>Three-phase active power</p> <p>P1=502kW</p> <p>P2=500kW</p> <p>P3=501kW</p>
	<p>Three-phase reactive power</p> <p>Q1=1kvar</p> <p>Q2=0kvar</p> <p>Q3=2kvar</p>
	<p>Three-phase apparent power</p> <p>S1=502kVA</p> <p>S2=500kVA</p> <p>S3=501kVA</p>



 <p>A digital display with three lines. The top line shows '1502' with a 'k' superscript. The middle line shows '0003' with 'kvar' to its right. The bottom line shows '1502' with 'VA' to its right. A Greek letter sigma (Σ) is located at the bottom right of the display area.</p>	<p>Total active power, Total reactive power , Total apparent power $\Sigma P=1502\text{kW}$ $\Sigma Q=3\text{kvar}$ $\Sigma S=1502\text{kVA}$</p>
 <p>A digital display with three lines. The top line shows '1.000' with 'PF' to its right. The middle line shows '1.000'. The bottom line shows '1.000' with a Greek letter sigma (Σ) to its right.</p>	<p>Power factor $\text{PFa}= 1.000$ $\text{PFb}=1.000$ $\text{PFc}=1.000$</p>
 <p>A digital display with two lines. The top line shows '1.000' with 'PF' to its right. The bottom line shows '1.000' with a Greek letter sigma (Σ) to its right.</p>	<p>Total power factor $\text{PF}=0.980$</p>

Table 2-2 Energy display pages



Display interface	Instruction
 <p>The display shows 'EP' with a small 'k' at the top right, '0 180' with 'Wh' at the top right, and '7600' below it.</p>	<p>Import total active energy EP=1807.6kWh</p>
 <p>The display shows 'EP-' with a small 'k' at the top right, '0000' with 'Wh' at the top right, and '0000' below it.</p>	<p>Export total active energy EP-=0.0kWh</p>
 <p>The display shows 'EQ' with a small 'k' at the top right, '000' with 'varh' at the top right, and '0.200' below it.</p>	<p>Import total reactive energy EQ=10.2kvarh</p>
 <p>The display shows 'EQ-' with a small 'k' at the top right, '000' with 'varh' at the top right, and '1.700' below it.</p>	<p>Export total reactive energy EQ-=11.7kvarh</p>

Table 2-3 Power quality display interface

Display interface	Instruction
 <p>The display shows 'THd' with a small 'k' at the top right, 'UA' below it, and '05.20' with '%' at the bottom right.</p>	<p>Total voltage distortion rate THDua=5.2%。</p>
 <p>The display shows 'THd' with a small 'k' at the top right, 'IA' below it, and '03.90' with '%' at the bottom right.</p>	<p>Total current distortion rate THDia=3.9%。</p>

2.3 Setting

The setting menu adopts hierarchical management mode: three rows correspond to three level menu information. The setting menu overview map is as follows:

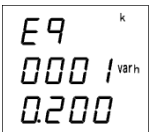
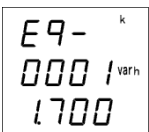
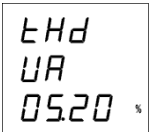
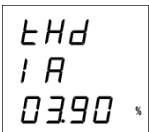
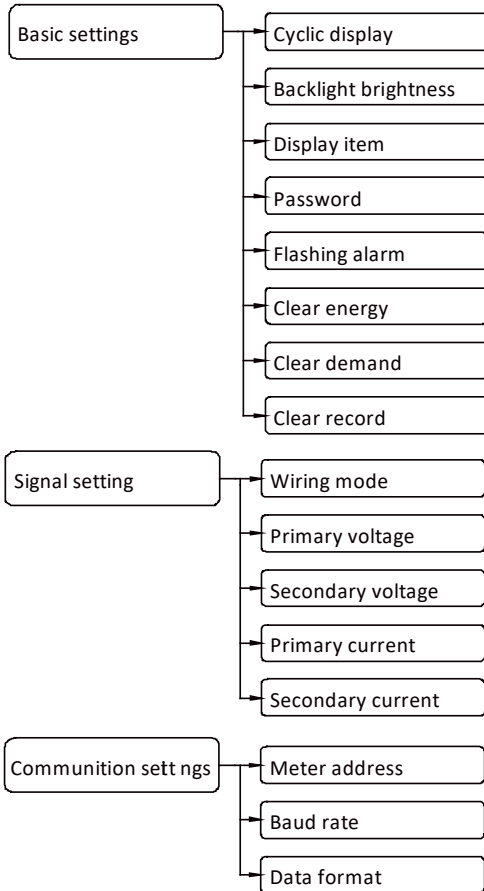
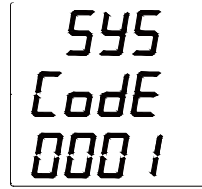

Table 2-4 Settings menu description

First level	Second level	Third level	Instruction
System setting 555	Password Code	0000~9999	User password
	Cyclic display CYC	0~60	0: no cyclic display 1~30: looping display,30 s apart
	LED brightness LIGH	0~4	0:Darkest4:Brightness
	Display item DISP	Voltage, current etc.	Default display page
	Flashing alarm ALR	0 30~120	0:Disable off-limit alarm flashing function 30~120:Threshold value%
	Clear energy CLRE	noorYES	NO: not clear energy YES: clear energy
	Clear demand CLRD	noorYES	NO: not clear demand YES: clear demand
	Clear record CLR̄	noorYES	NO: not clear record YES: clear record
Signal input 1 nPt	Wiring mode nEt	n33 n34 n12	n33: three phase three wire n34: three phase four wire n12: single phase
	Primary voltage Pt 1	1~9999 kV	PT Primary side voltage rating
	Secondary voltage Pt 2	1~690 V	PT secondary side voltage rating
	Primary current Ct 1	1~9999 kA	CT primary side current rating
	Secondary current	1~6 A	CT secondary side current rating

	CE 2		
First communication Coñ 1	Meter address Addr	0001~0247	Set the meter address: 1~247
	Baud rate bAUD	1200~9600	Unit:bps
	Data format dAtA	n.B. 1o.B. 1 E.B. 1n.B. 2	n.B. 1: no check, one stop bit o.B. 1: dd check, one stop bit E.B. 1: even check, one stop bit n.B. 2: no check, two stop bits
version number uEr	1001 189A		Software version number

Operation instruction for keys

The “<” key is used to add and subtract the menu's toggle key and value. The “↵” key is used to enter the lower menu and confirm the value after modification.

To increase or decrease the value of a hundred thousand bits:

Press the “↵” key to move the cursor to the value you want to modify, press the “<” key to modify the corresponding value.

Enter the setting status:

Enter the setting state to pass the password authentication. Press the “↵” button in the meter display state, the meter displays “Code”, press the “↵” button to confirm the password authentication interface, and enter the password through the “<” and “↵” keys. The initial password of the system is 0001. Press “↵” to confirm. If the password is correct, the meter enters the setting interface. If the password is incorrect, the interface will not change.

Exit the setup status:

Press “←”+“←” in any setting interface, the meter will display “SAVE”, then press “←” and the meter will display “no”. At this time, there are two operations:

- (1) Save and exit: press “←” to switch to “SAVE-YES”, then press “←” to save the setting parameters to exit;
- (2) Exit without saving: Press “←” to exit without saving the setting parameters.

2.3.1 System parameter setting

If the user password is changed to 112 and the energy data is cleared, the menu operation steps are as follows:

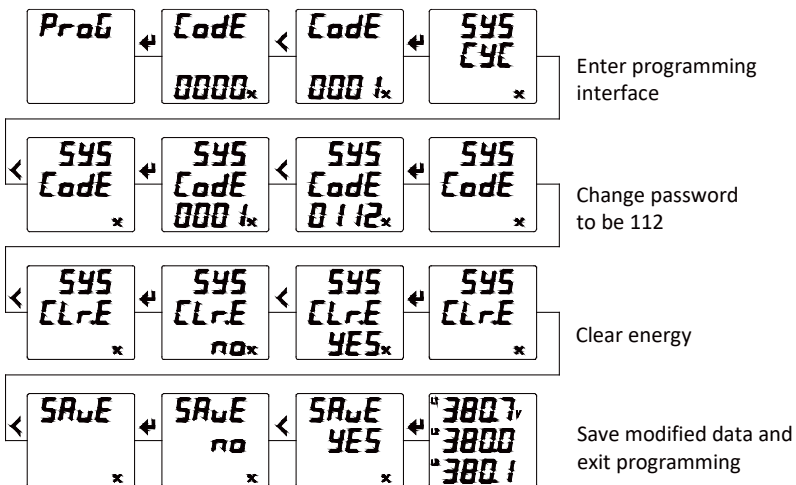

2.3.2 Signal input setting

If the signal of the meter is 10kV/100V, 2000A/5A, the menu operation steps are as follows:

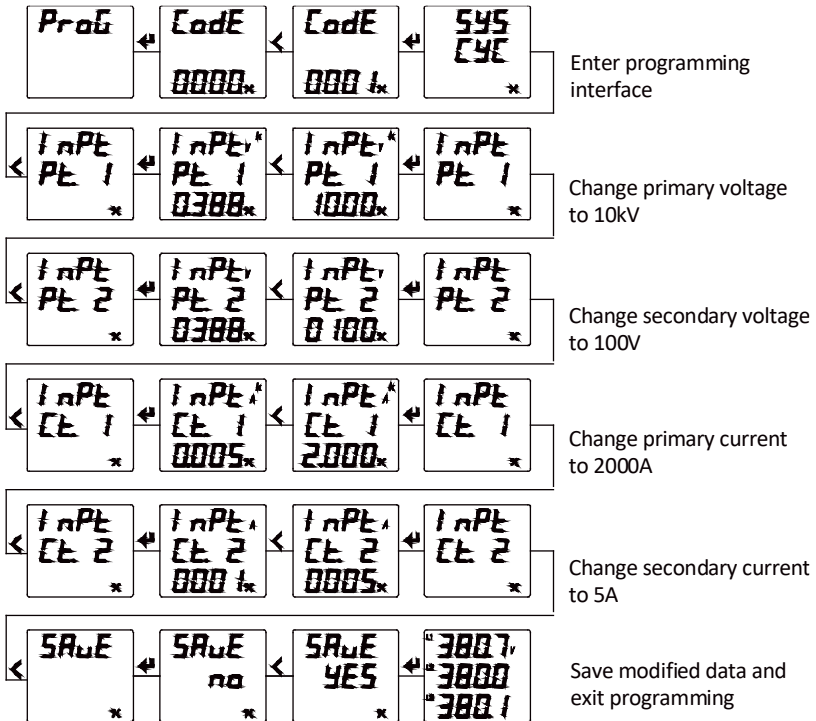

2.3.3 Communication setting

If the instrument communication address is set to 12, the baud rate is 9600, and the data format is E81 even parity mode, the menu operation steps are as follows:

